

NEW  
**RENAULT ARKANA**  
**E-TECH FULL HYBRID**  
145 HP



April 2024



# hybrid by nature

**Designed to turn heads, new Renault Arkana E-Tech full hybrid reinvents the sports SUV. With a streamlined silhouette, raised ground clearance and restyled grille, it successfully combines a dynamic shape with a spacious interior enhanced by a large boot.**



**Discover the iconic Sport-Chic version, esprit Alpine, and enjoy responsive driving with the E-Tech full hybrid 145hp engine.**

**sports SUV**

**3 seats  
at the rear**

**up to  
480 litres  
of boot volume**

**E-Tech full  
hybrid 145 hp  
engine**

**up to  
1,00km  
of range<sup>(1)</sup>**

**up to 18 advanced  
driver-assistance  
systems<sup>(2)</sup>**

(1) with a full tank of petrol according to WLTP data.  
(2) depending on version.

# **interactive menu**

**01. design**

**02. driving pleasure**

**03. interior experience**

**04. multimedia**

**05. interior space**

**06. advanced driver-  
assistance systems**

**07. customisation**

## sportiness embodied

With a completely restyled grille that incorporates the new Renault emblem, the front end adds to the vehicle's design. At the rear, the black twin exhaust and wide spoiler emphasise its dynamic character. In the esprit Alpine and techno version, the emblematic F1® blade oozes sportiness.



UK spec may vary

The new glossy black chrome-finish grille with unstructured diamonds creates a unique personality.



The rear end does not go unnoticed with its translucent smoky lights, new dark chrome Renault emblem and black Arkana marking.



esprit Alpine badge on the front wings and robust look with its new 19" wheels.\*

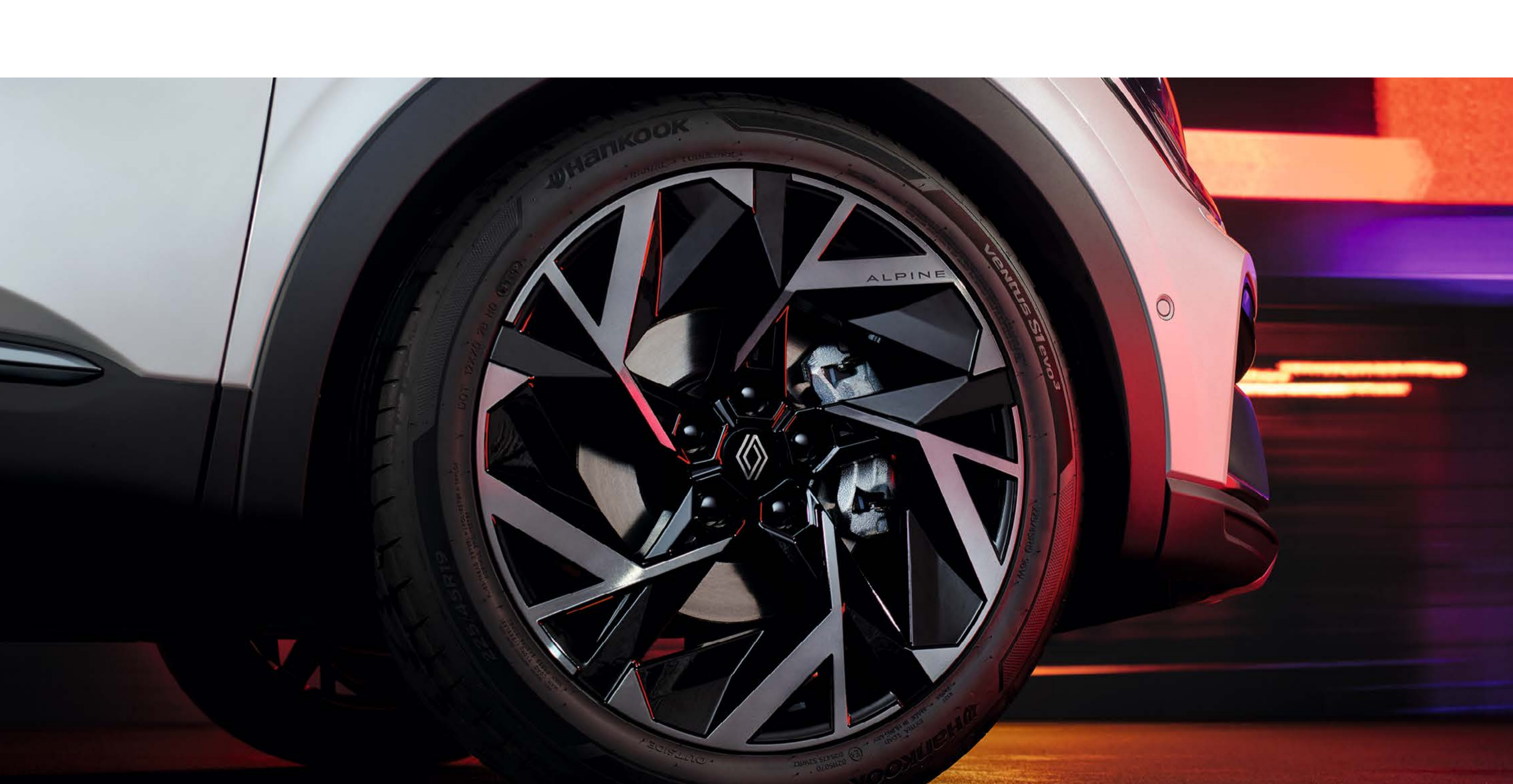

The interior has an elegant and sporty atmosphere thanks to upholstery enhanced with blue top-stitching. The steering wheel comprises red, white and blue stitching. The Alpine logo - a sign of exclusiveness - embellishes the front seats.



special upholstery in biobased textured coated fabric / suedette on esprit Alpine version\*

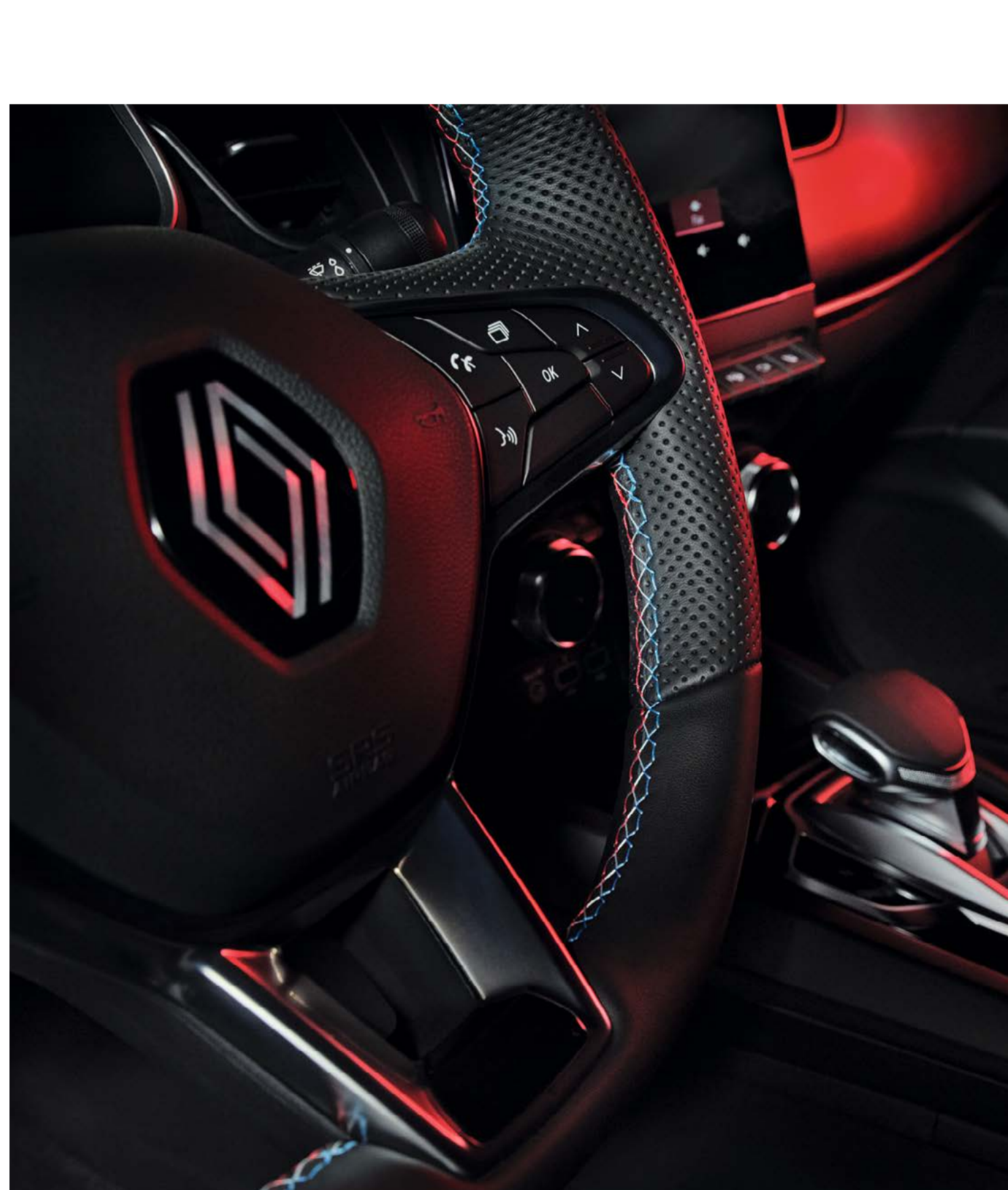

heated steering wheel covered in perforated textured coated fabric on esprit Alpine version\*

\*esprit Alpine

## 02. driving pleasure

# E-Tech full hybrid 145hp

E-Tech  
**full hybrid**  
**145 hp**

up to  
**80%**  
electric driving  
in town<sup>(1)</sup>

up to  
**60.1 mpg**  
(WLTP combined)<sup>(4)</sup>

up to  
**1,00km**  
of driving range<sup>(2)</sup>

from  
**4.7 l/100 km**  
fuel consumption<sup>(3)</sup>

from  
**105 g/km**  
CO<sub>2</sub> emissions<sup>(4)</sup>



**The E-Tech full hybrid 145 hp makes the car a pleasure to drive. As it is always started in electric mode, acceleration is crisp and dynamic. In town or on the open road, enjoy quiet, responsiveness and agility.**

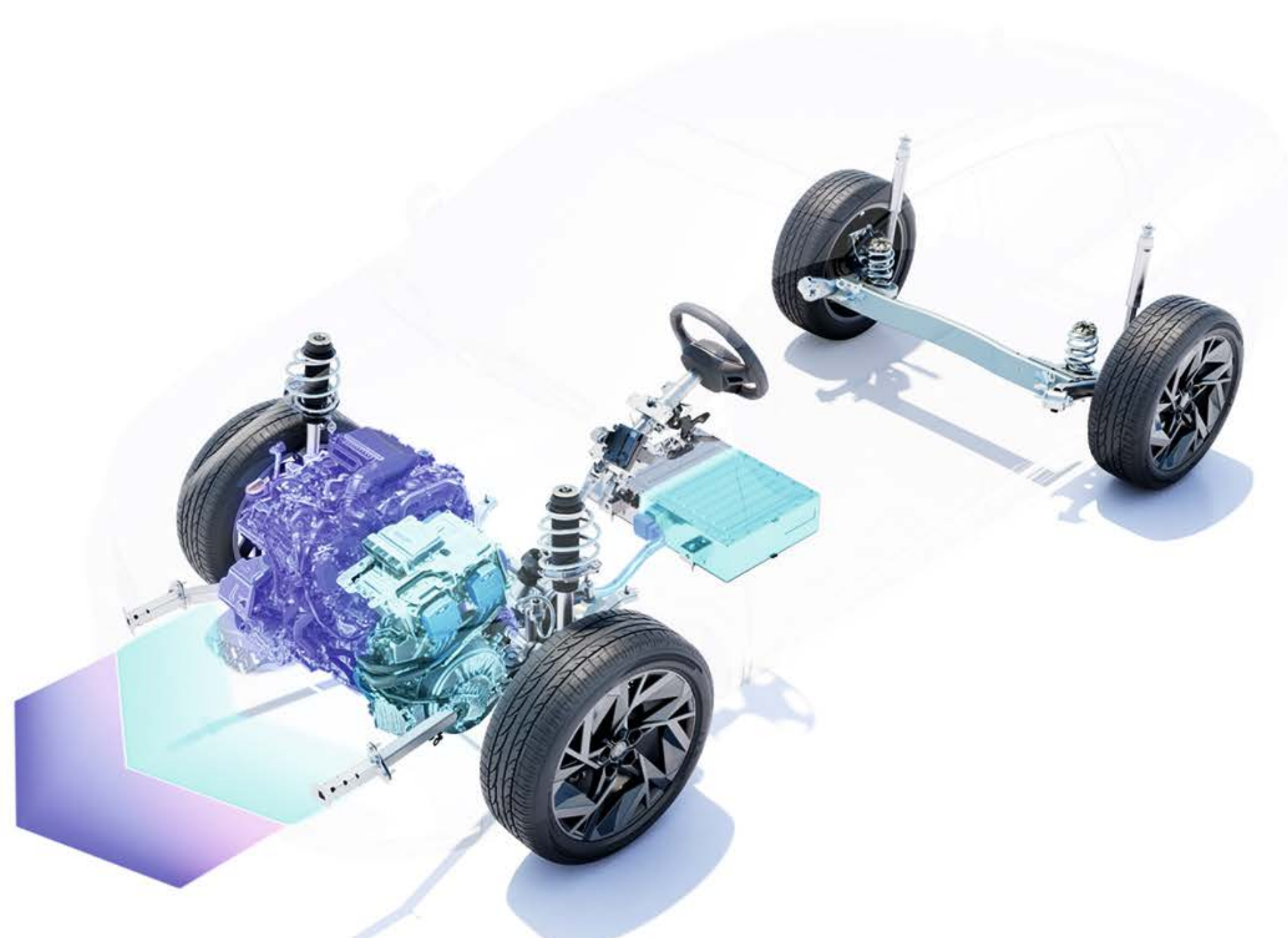

### E-Tech full hybrid 145 hp engine

In town, drive up to 80% of the time in electric mode and with minimal noise, while automatically charging the battery when decelerating or braking. No need to plug your vehicle into a power outlet.

E-Tech full hybrid 145 hp	
technology	1230V battery + 2 electric engines + 1 internal combustion engine
fuel consumption <sup>(3)</sup>	from 4.7 l/100 km
CO <sub>2</sub> emissions <sup>(3)</sup>	from 105 g/km
energy recovery via deceleration and braking	yes
management of energy recovery level	yes
electric assistance to the internal combustion engine	yes
electric driving in town <sup>(1)</sup>	up to 80% electric driving in town <sup>(1)</sup>

(1) depending on battery charge status and driving style / Renault internal source / November 2021.

(2) with a full tank of petrol according to WLTP data.

(3) values from 4.7 l/100 km of fuel consumption and from 105 g/km of CO<sub>2</sub> emissions, according to WLTP data / UTAC source / November 2021.

(4) for an E-Tech full hybrid engine according to WLTC City data / UTAC & IDIADA source / November 2021.

# immersive pleasure

**"Premium-touch" materials, heated driver's seat and Multi-sense technology offers you three driving modes for a personalised experience.**



model shown esprit Alpine  
e-shifter gear lever not available in Ireland

**The slate finish of the dashboard and door panels is elegant and adds to the cockpit's modern look.\***

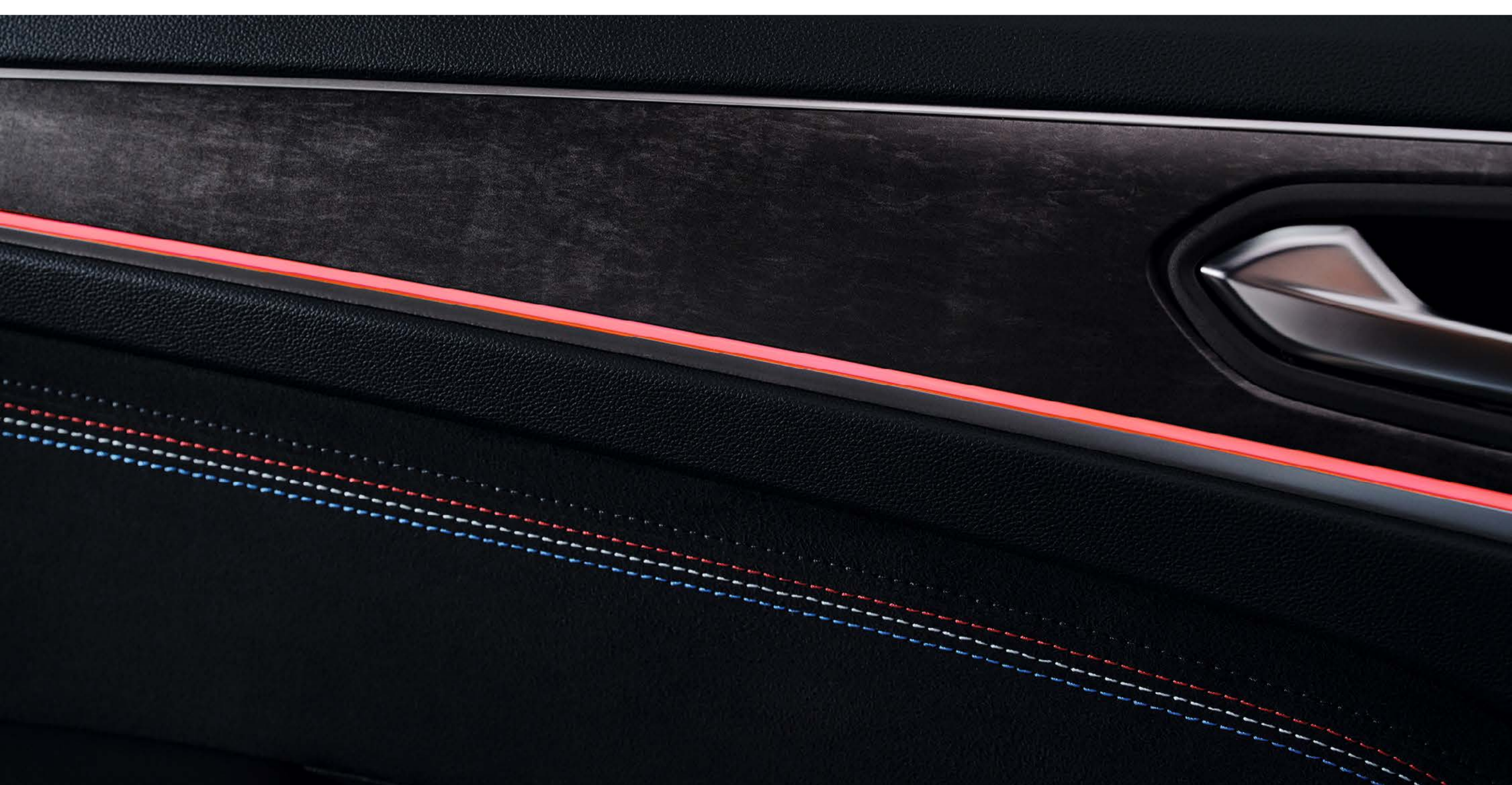

\*esprit Alpine

## intuitive connectivity

The easy link multimedia system and its 9.3" central touch screen\* facilitate access to navigation, widgets and your customised profile. Keep essential driving information in your direct view by displaying it on the 10" configurable digital instrument panel.\*



Access your applications, playlists, contacts and favourites directly on the central screen thanks to smartphone mirroring. The wireless charger always ensures an optimal level of independence.\*



e-shifter gear lever not available in UK

With the My Renault application, manage your vehicle remotely and easily through your smartphone: connected services, location of the vehicle, service history, service reminders and garage appointment bookings.

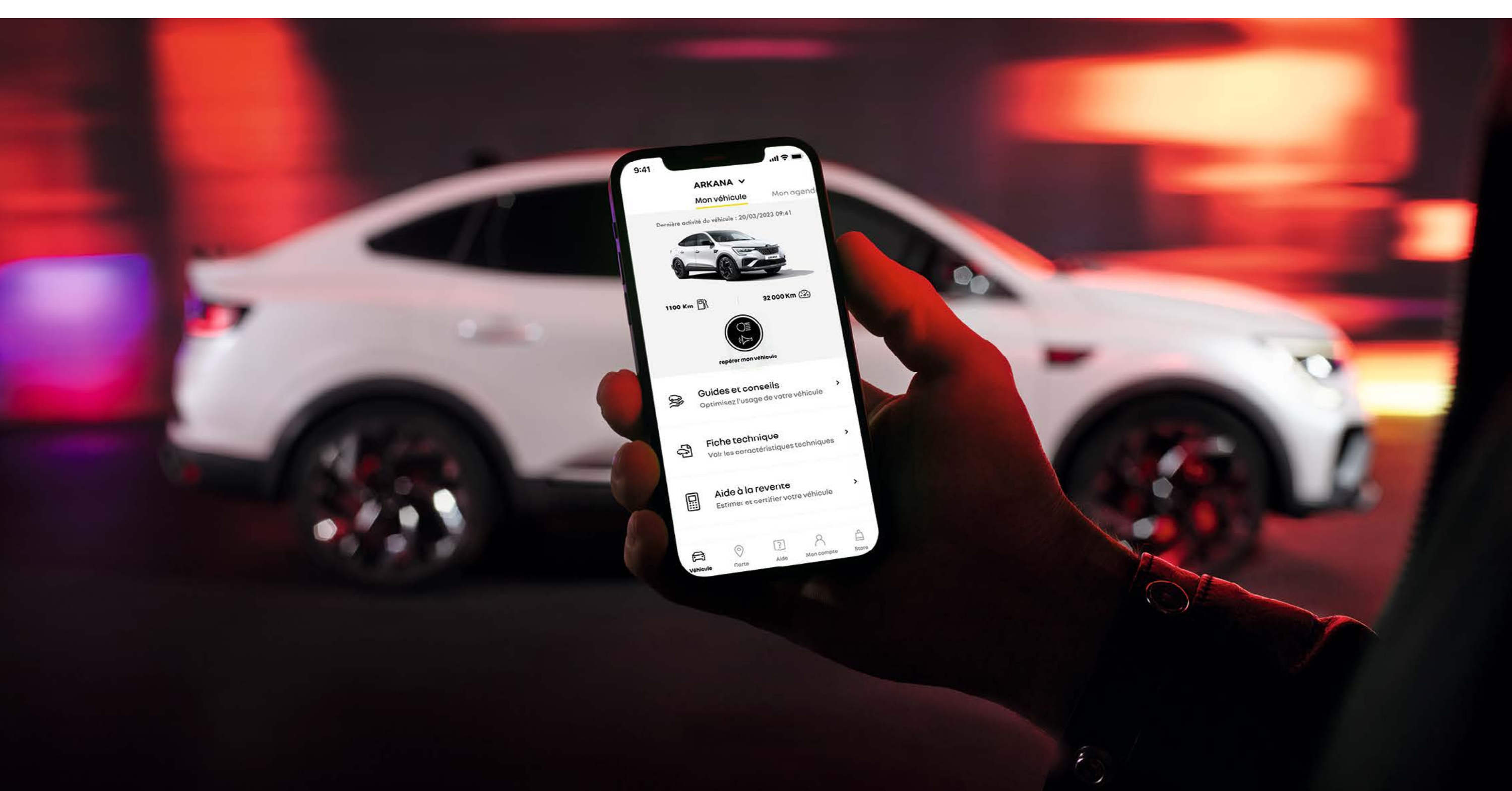

\*from techno

## generous interior space

The sportiness of the lines complements the generous interior and large boot of up to 480 litres.



The carefully designed rear space comprises three seats and 21 cm of knee room.

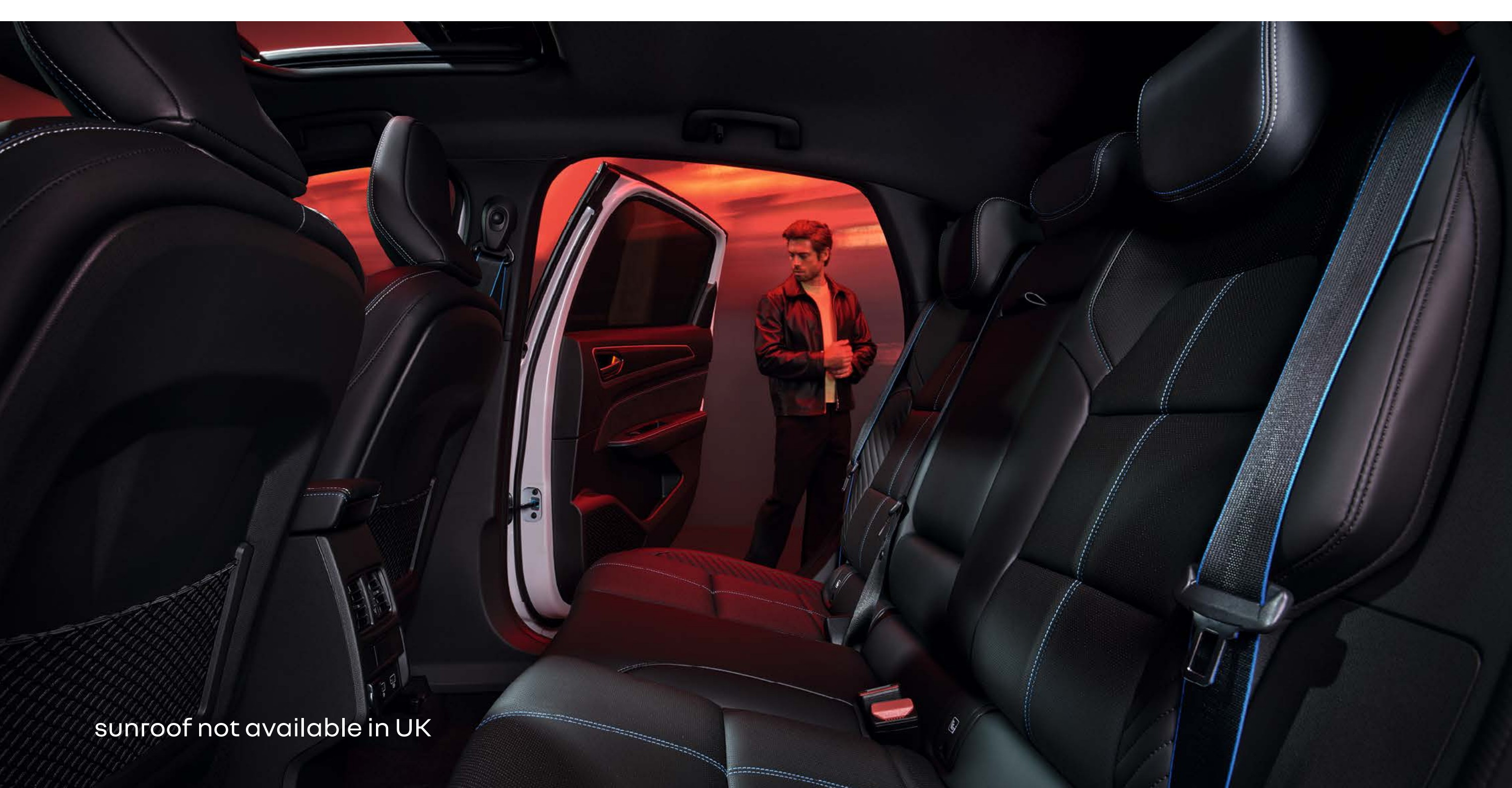

sunroof not available in UK

In the low position, the height-adjustable floor maximises the loading capacity of 1,263 litres; in the high position, it facilitates the loading of heavy objects. A configuration that also gives you a completely flat surface, once the 1/3-2/3 rear bench seatbacks are folded down.

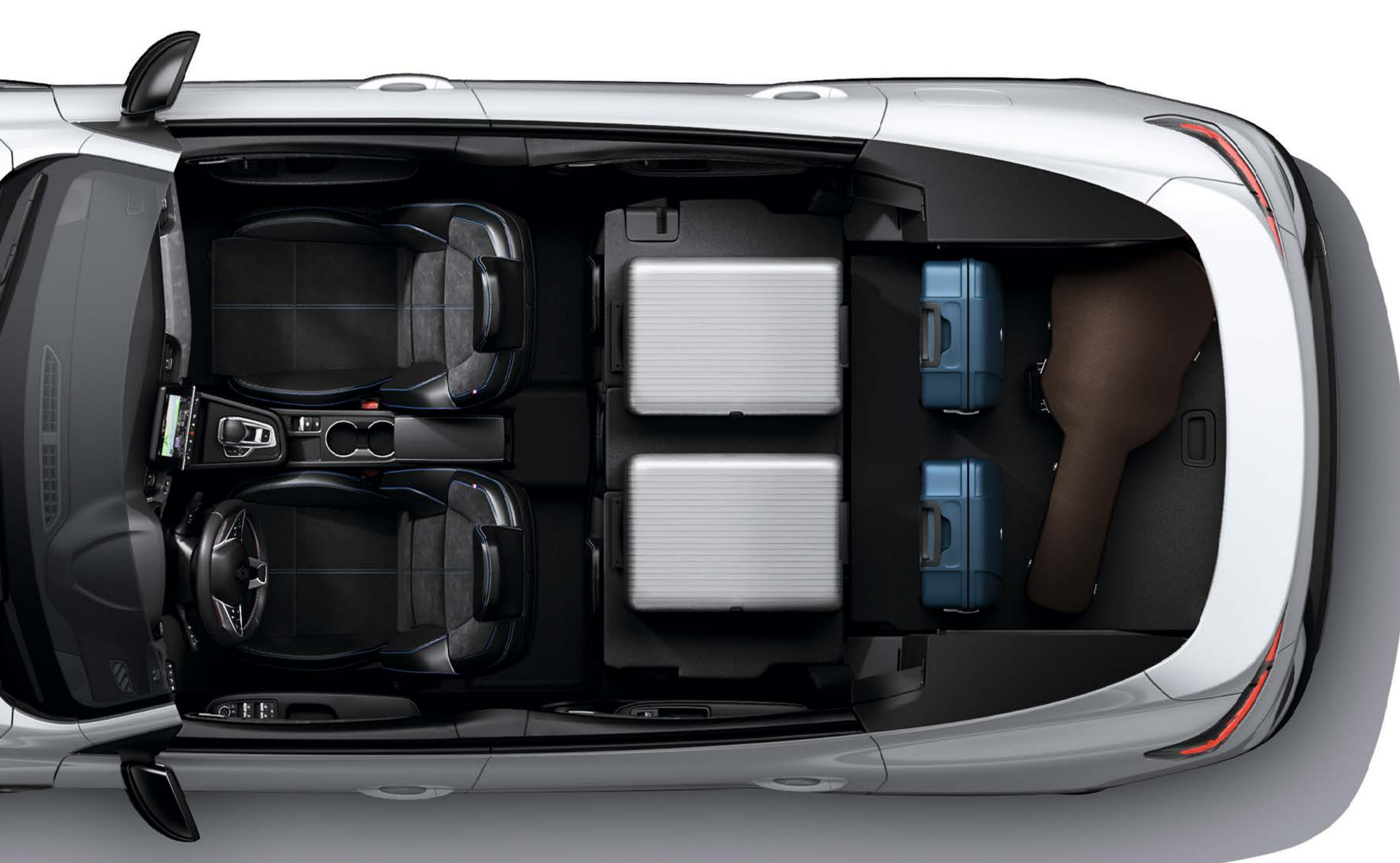

e-shifter gears are not available on Irish spec



## 06. advanced driver-assistance systems



# up to 18 advanced driver-assistance systems

As part of the human first program, new Renault Arkana E-Tech full hybrid offers up to 18 advanced driver-assistance systems.

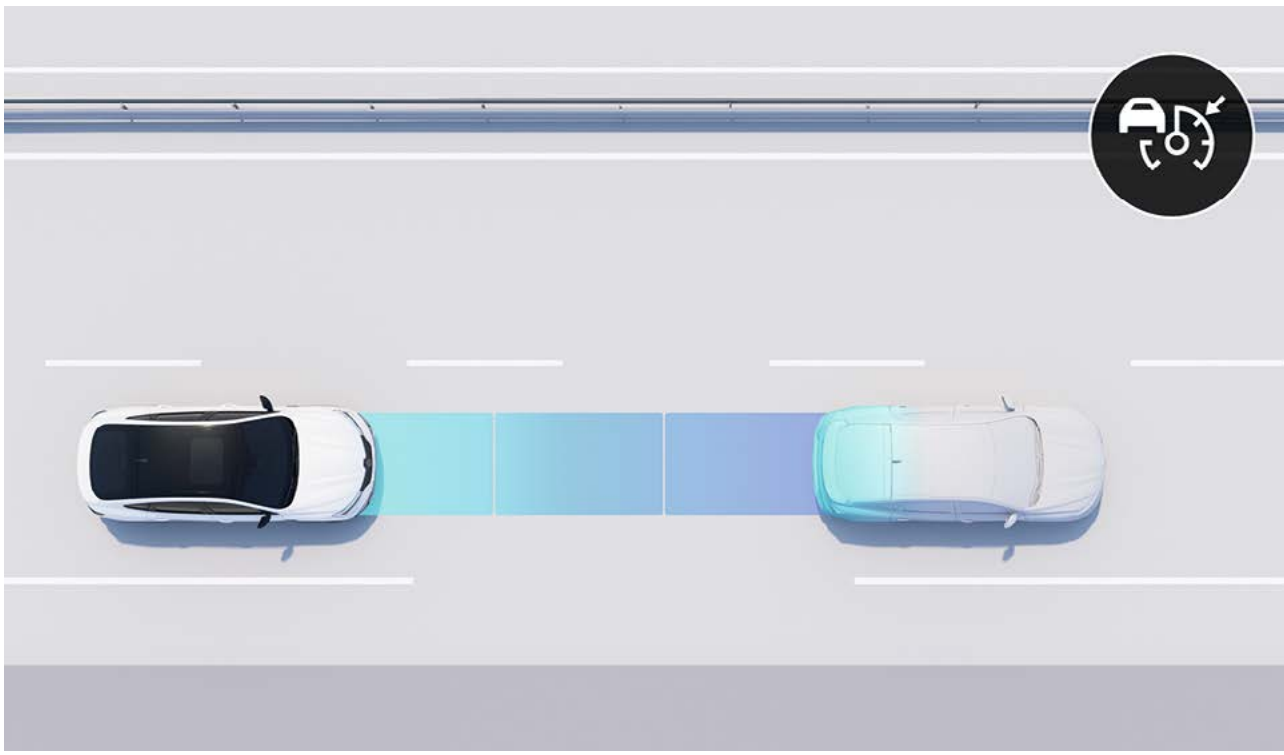

**active driver assist**  
The adaptive cruise control regulates your speed by taking the road environment into account, maintains safe distances and ensures you remain in lane. When traffic slows down, the vehicle stops and restarts automatically.

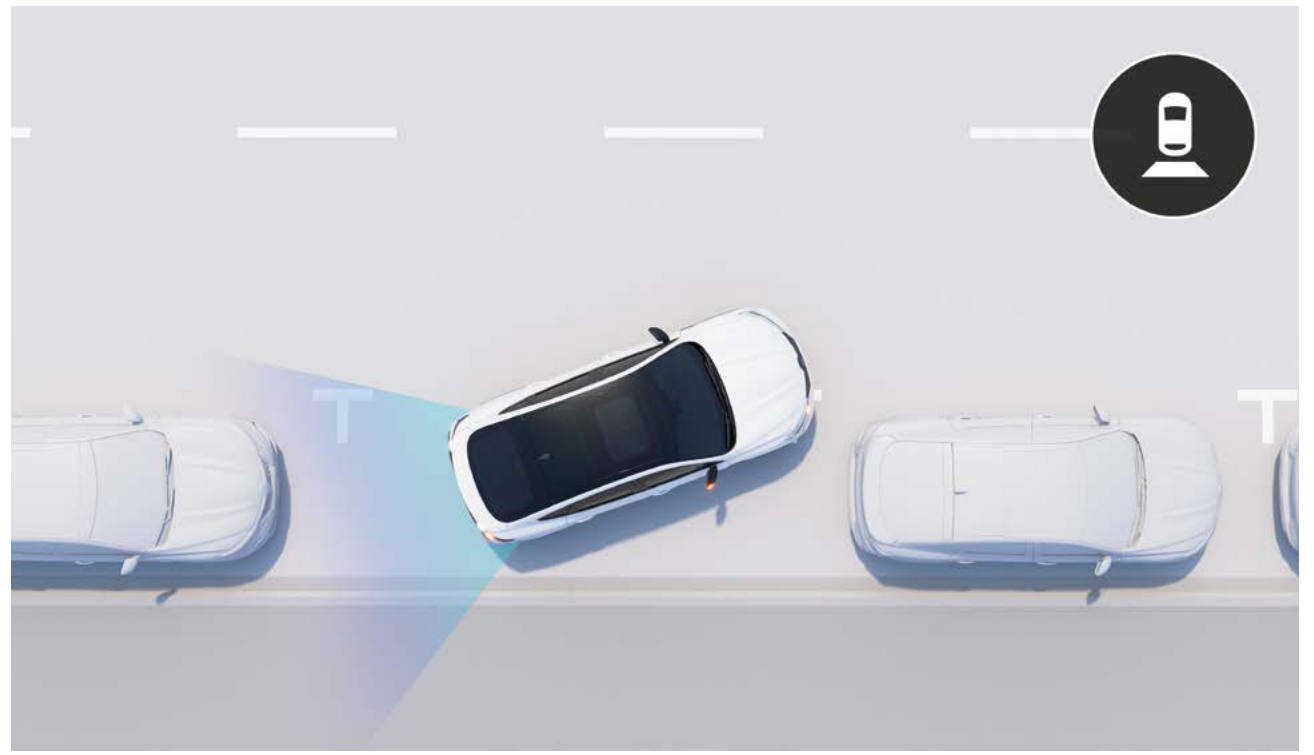

**rear view camera**  
Provides a rear view on the screen when you engage the reverse gear. Superimposed outlines make your manoeuvres easier and safer.

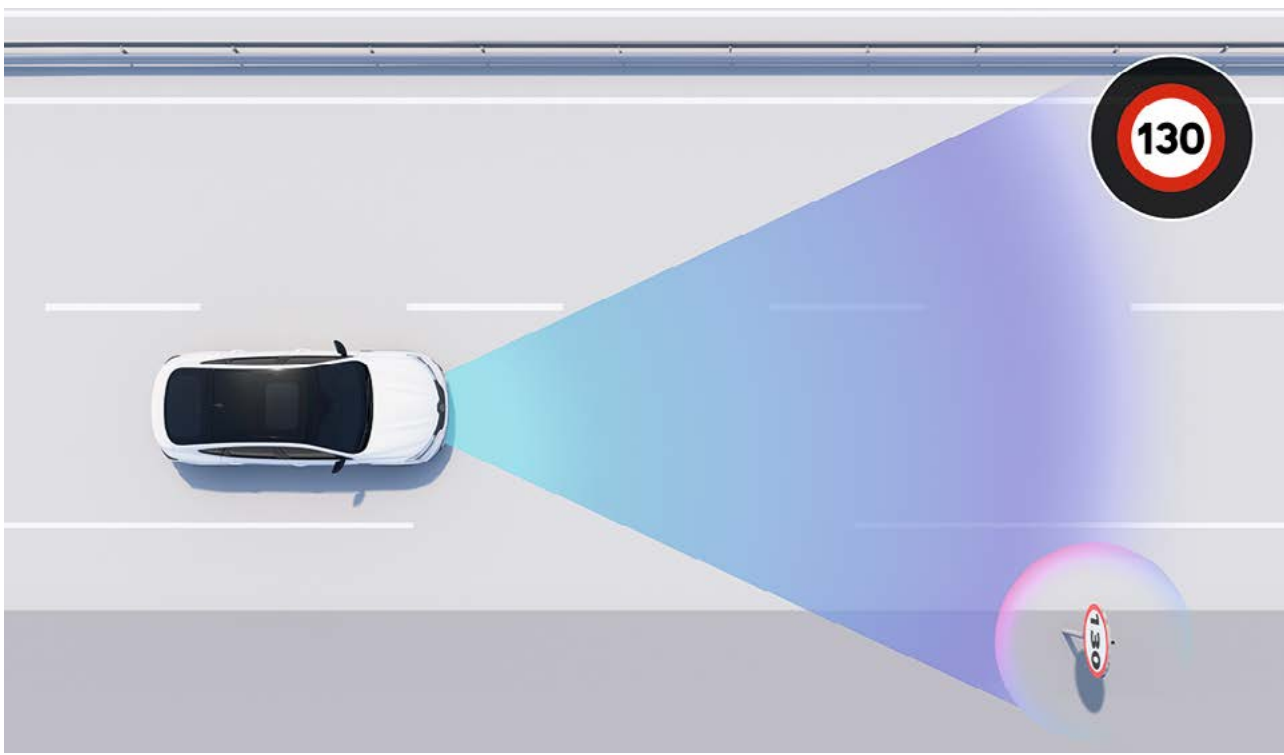

**road sign recognition and speeding alert**  
It keeps you informed via the instrument panel of the speed limits along your route thanks to a camera.

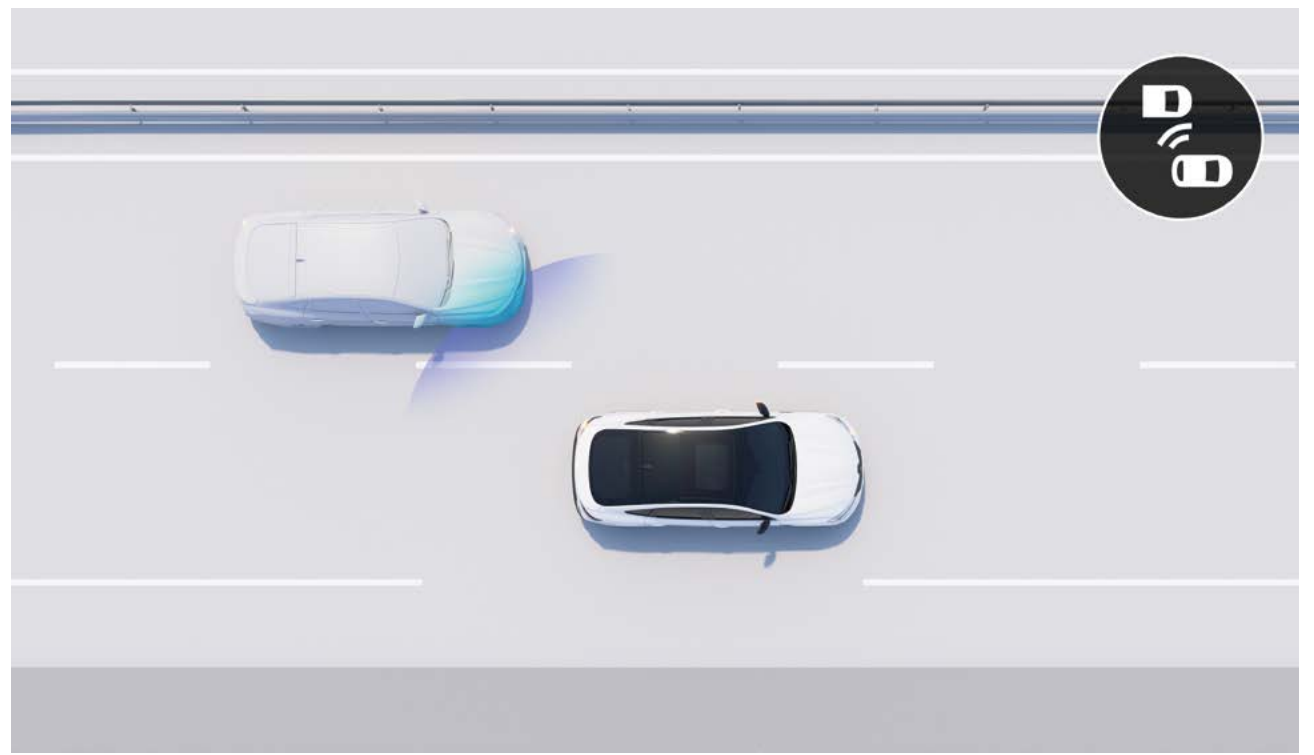

**blind spot warning**  
Active from 10 mph, the system uses the rear side sensors to detect the presence of a vehicle in a non-visible rear side area (blind spot) and warn the driver by switching on a warning light in the door mirror on the side where the vehicle is not visible.



**rear cross parking alert when reversing**  
Exit your parking spot more comfortably. Renault Arkana, equipped with sensors, signals the arrival of a vehicle that you may not have seen.

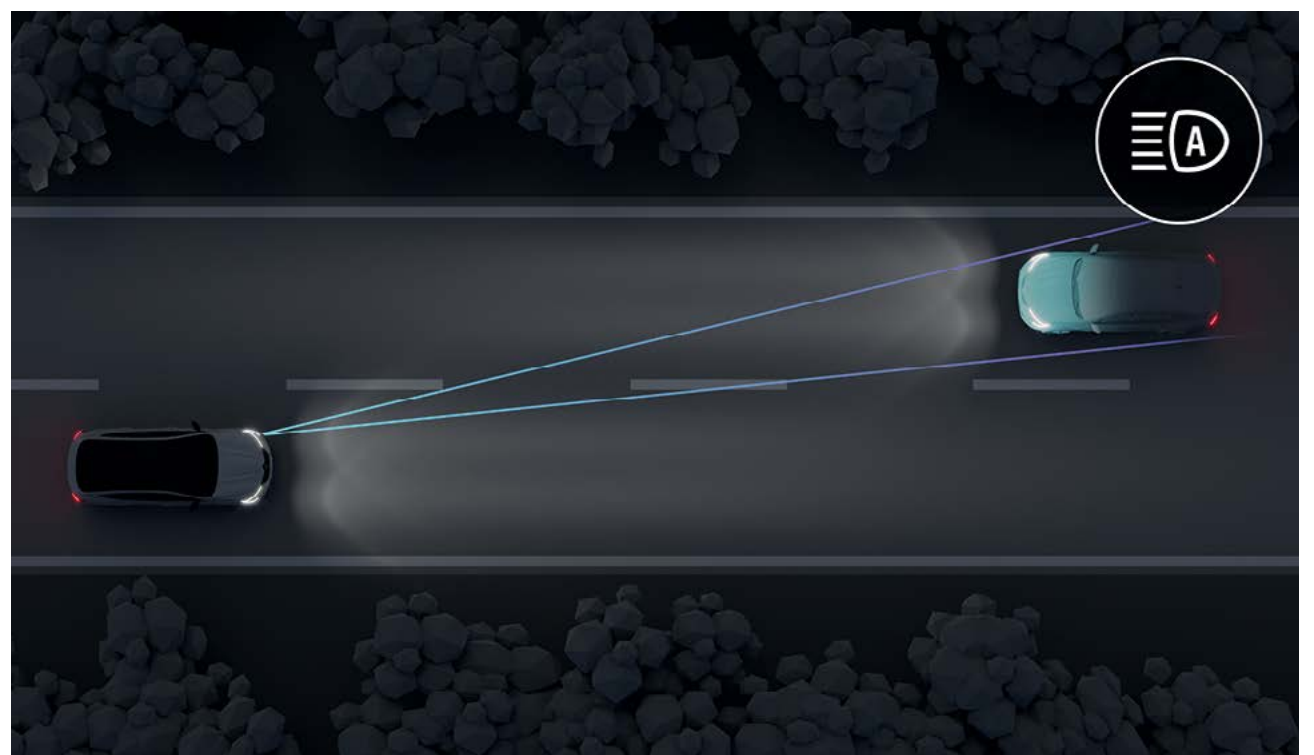

**automatic main-beam/dipped headlight activation**  
Thanks to a camera located on your windscreen that analyses light flows, the system automatically switches between main beam and dipped headlights.

### driver-assistance systems

- active driver assist: adaptive cruise control + lane centering
- hill start assist
- speed limiter
- road sign recognition
- road sign recognition and speeding alert
- cruise control

### park assist systems

- rear parking sensors
- front parking sensors
- rear cross parking alert when reversing
- rear view camera

### safety assistance

- safe following distance warning (information on the driver's screen)
- lane departure warning
- lane keeping assist
- blind spot warning
- automatic main-beam/dipped headlight activation
- automatic emergency braking (pedestrian/cyclist)
- automatic headlights and windscreen wiper with rain sensors across the range

please view individual trims for details of standard ADAS

## 07. customisation

# colours



**fresca white (non-mp)**



**universal white (mp)**



**dusky black (mp)**



**platinum grey (mp)**



**flame red (mp)**



**zanzibar blue (mp)**



**midnight blue (mp)**

non-mp: non-metallic paint;  
mp: metallic paint.  
photos not contractually binding.

## 07. customisation

# interior trims



### evolution

- easy link 7" with navigation: connected multimedia system with 7" touch screen
- 1/3-2/3 split folding rear bench seat
- 17" bahamas grey alloy wheels



### techno

- easy link 9.3" with navigation: connected multimedia system with 9.3" touch screen
- wireless phone charger integrated into the centre console
- 18" silverstone alloy wheels



### esprit Alpine (techno +)

- active driver assist
- heated front seats and steering wheel
- 19" esprit Alpine black and grey diamond-cut alloy wheels

## 07. customisation

# upholstery

### evolution



**black titanium fabric upholstery**

### techno



**black textured coated fabric upholstery**

### esprit Alpine



**special upholstery in biobased textured coated fabric / suedette**

# wheels

### evolution



**17" bahamas grey alloy wheels**

### techno



**18" silverstone alloy wheels**

### esprit Alpine



**19" esprit Alpine black and grey diamond-cut alloy wheels**

## 06. customisation

# engines

mild hybrid tce 140 hp	mild hybrid tce 160 hp	E-Tech full hybrid 145 hp
<b>fuel</b>		
unleaded petrol (E10)	unleaded petrol (E10)	unleaded petrol (E10) + full hybrid
<b>maximum power kW (hp) / engine speed (rpm)</b>		
103 kW (140) at 4,500 - 6,500 rpm	116 kW (160) at 5,500 rpm	69 kW (95) at 5,600 rpm
<b>maximum torque (Nm) / engine speed (rpm)</b>		
260 Nm at 1,750 to 3,500 rpm	270 Nm at 1,800 to 3,750 rpm	148 Nm at 3,600 rpm
<b>gearbox</b>		
automatic transmission with double-clutch and 7 speeds	automatic transmission with double-clutch and 7 speeds	multimode automatic with dog-clutch and 15 combinations
<b>volumes and weights</b>		
<b>kerb weight (kg)</b>		
1,336	1,347	1,435
<b>batteries</b>		
<b>type</b>		
lithium-ion	lithium-ion	lithium-ion
<b>voltage (V)</b>		
12	12	230
<b>capacity (kWh)</b>		
0.13	0.13	1.2
<b>fuel consumption and emissions<sup>(1)</sup> WLTP<sup>(2)</sup> (Best case / Worst case)</b>		
<b>CO<sub>2</sub> (g/km)</b>		
130/134	135/136	105/111
<b>consumption over a combined cycle (l/100 km)</b>		
5.8/5.9	6.0	4.7/4.9

(1) fuel consumption and CO<sub>2</sub> emissions are certified using a standard, regulatory method. It is identical for all manufacturers and allows vehicles to be compared.

(2) WLTP (Worldwide Harmonized Light Vehicle Test Procedures): this new protocol provides results much closer to those found in daily use compared with the NEDC protocol.

# dimensions and volumes

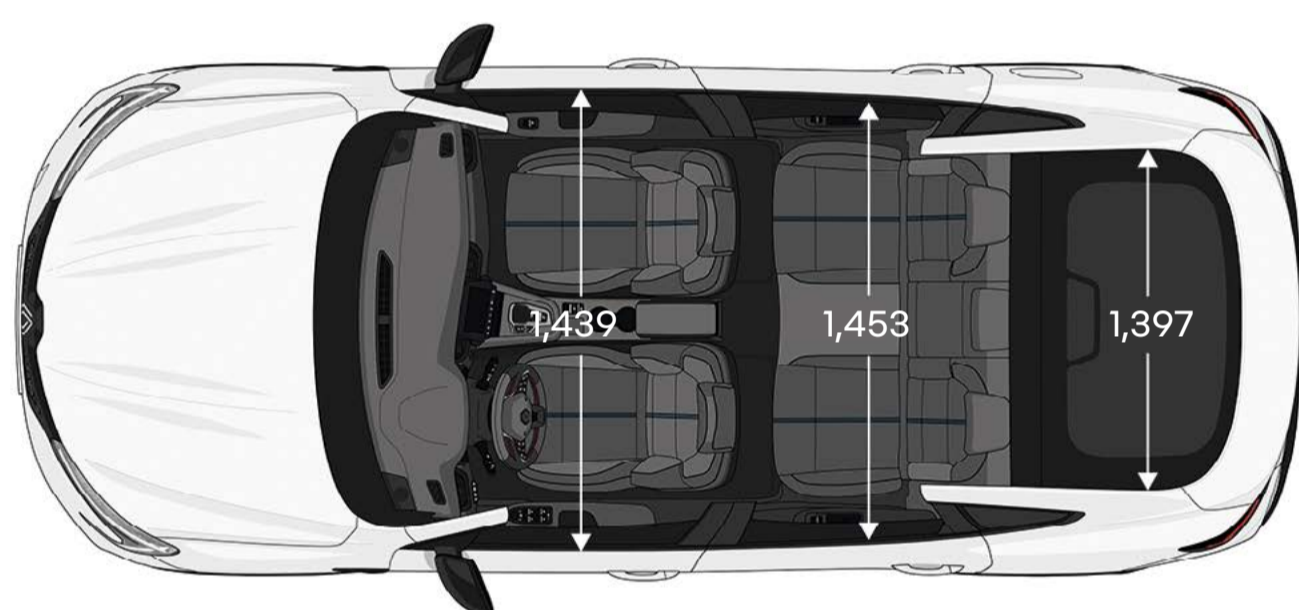
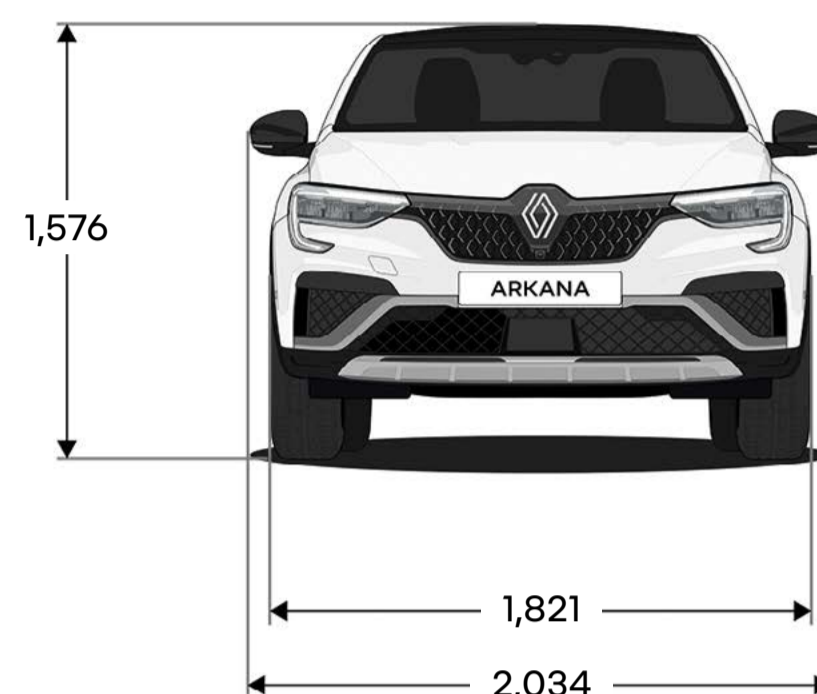
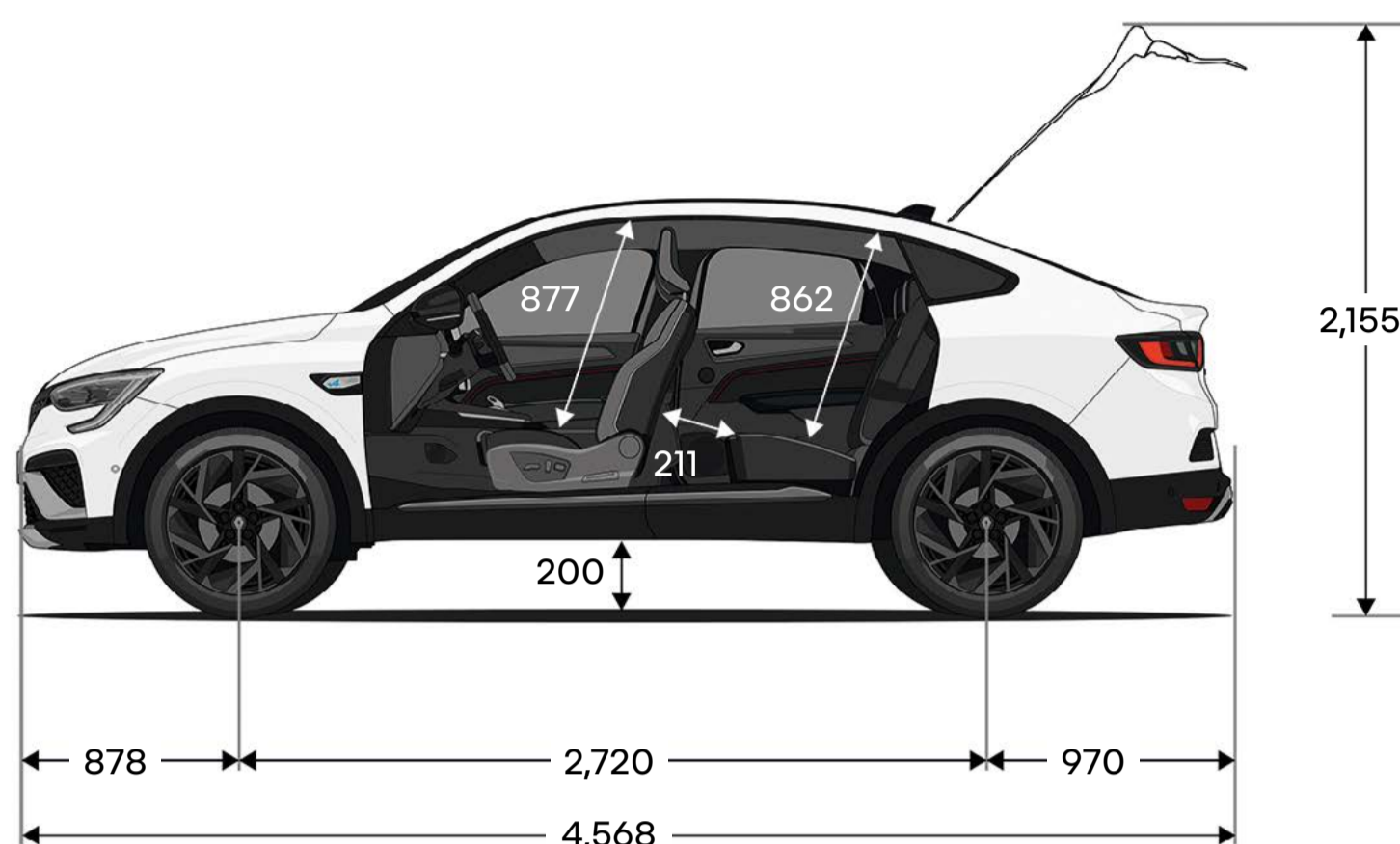

## boot volume - VDA standard (litres)

## full hybrid

min. boot volume

480

max. boot volume

1,263

dimensions in (mm).

# Renault services

## 5 years warranty

Our new vehicles, cars & vans come with warranty protection, providing worry free motoring for 5 years or 150,00 km as standard - one of the best warranty covers on the Irish market. For further details go to [www.renault.ie/warranty](http://www.renault.ie/warranty)

## 5 years roadside assistance

Should you need it, we'll provide emergency roadside repairs or tow you to the nearest Renault Dealer. For further details visit [www.renault.ie/assistance](http://www.renault.ie/assistance)

## customer relations

Renault knows the value of communicating with its customers and we have established effective ways to keep in touch with you. If after speaking to your local Renault dealership you are not completely satisfied, please contact the Renault Ireland Customer Service Team on 1800 771 771 (Mon-Fri 8am to 6pm. Closed Saturday, Sunday and on Bank Holidays. Live Chat Mon-Fri 8am to 6pm). You can also visit [www.renault.ie](http://www.renault.ie) or write to us at: Renault Ireland, Cedar House, Joyce Way, Park West Business Park, Dublin, D12 RW59

† Calls to 1800 numbers are free if used as part of your inclusive mobile minutes and are charged at local rates from landlines.

# Renault care service

**We are always by your side to make your driving experience easier and save you time with the maintenance of your Renault: online quotes and appointments, fixed price packages, maintenance contracts, insurance and assistance, personalised My Renault programme, etc. Take advantage of our simple and fast solutions tailored to your needs.**



Every precaution has been taken to ensure that the contents of this brochure were accurate and up-to-date at the time of its release. This document has been created using pre-production and prototype models. In line with its policy of continuous product improvement, Renault reserves the right to modify the specifications, vehicles and accessories described and featured at any time. Any such modifications are communicated to Renault dealers as quickly as possible. Depending on the country of sale, versions may differ and some equipment may be unavailable (standard, optional or accessory). Please contact your local dealer for the latest information. For reasons to do with the medium, the colours featured in this document may differ slightly from those of the actual paintwork or interior trim. All rights reserved. Reproduction in any format and by any means of all or part of this brochure is prohibited without prior written authorisation from Renault.

Publicis – photo credits: S. Staub, © Renault Marketing 3D-Commerce – April 2024.

Renault recommends 

